

Perfil MS 41-75/65/3,0

Carga admissível com aplicação de carga centralizada

L [cm]	41-75/65/3,0 [N]	41-75/65/3,0 D [N]
20	30089	86032
40	15037	43002
60	10017	28653
80	7504	21474
100	5994	17162
120	4986	14285
140	4265	12227
160	3722	10682
180	3300	9478
200	2960	8512
220	2682	7721
240	2449	7060
260	2208	6499
280	1886	6018
300	1626	5599
320	1412	5231
340	1233	4906
360	1083	4615
380	954	4354
400	844	4119
420	748	3905
440	664	3682
460	590	3336
480	524	3031
500	465	2760
520	412	2519
540	365	2302
560	321	2108
580	282	1932
600	246	1772

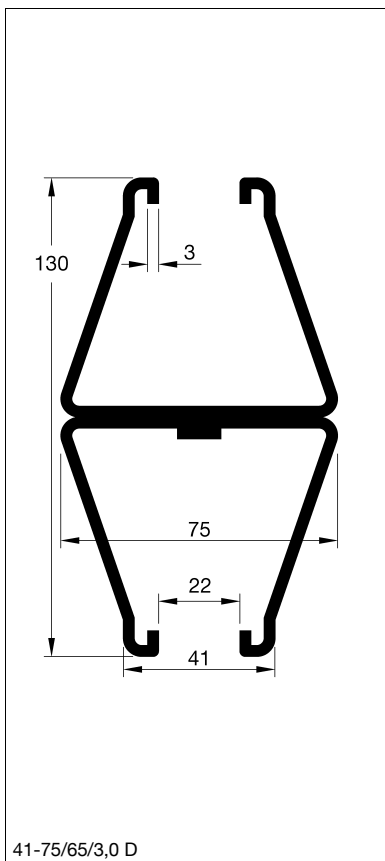
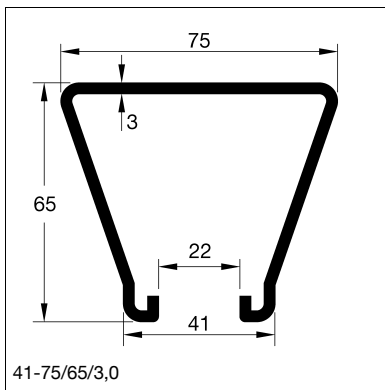

Cálculos de acordo com RAL GZ-655-C

$$\sigma_{zul} \leq 185 \text{ N/mm}^2$$

$$f \leq L/200$$

